













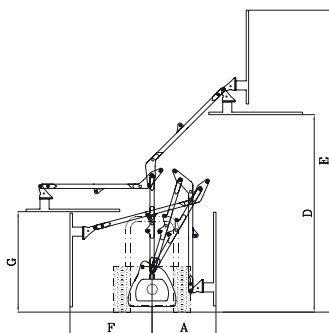

FLY 120



-  PER MINITRATTORI DEL GRUPPO 1 SPROVVISTI DI IMPIANTO IDRAULICO INDIPENDENTE
-  FOR MINI-TRACTORS OF GROUP 1 WITHOUT AN INDEPENDENT HYDRAULIC SYSTEM
-  POUR MICRO-TRACTEURS DE GROUPE 1 SANS IMPLANT HYDRAULIQUE INDÉPENDANT
-  FÜR KLEINEN TRAKTOREN VON DER GRUPPE 1 OHNE EINE UNABHÄNGIGE HYDRAULISCHE ANLAGE
-  PARA MINITRACTORES DEL GRUPO 1 LOS CUALES NO LLEVAN KIT HIDRÁULICO INDEPENDIENTE
-  KOMPAKT TRAKTOROKHOZ - 1 KATEGÓRIÁJÚ 3 PONT - TRAKTORHIDRAULIKÁRÓL



Modello Model	A	D	E	F	G	Peso Weight		
FLY 120	800	2700	4250	-	-	-		
								220

Modello Model		Lt. 	Ø MAX		
FLY 120	cm 120	40	cm 3	kg 500 HP 16/30	cm 900



Frontoni Maurizio s.n.c. di Frontoni Maurizio & C.
Via Besenzone, 1/F - 29016 Cortemaggiore (PC) Italy
Tel. +39 (0) 523 839959 - Fax +39 (0) 523 839512
frontoni@frontoni.net www.frontoni.net

