













SPIDER 150

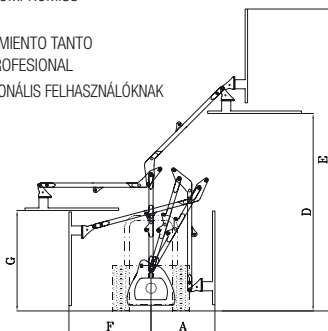

-  L' ATTREZZATURA CHE FORNISCE UN PERFETTO COMPROMESSO DALL' HOBBISTA AL PROFESSIONISTA
-  THE EQUIPMENT WHICH SUPPLIES A PERFECT COMPROMISE FROM THE HOBBYIST TO THE PROFESSIONAL
-  L'OUTIL FOURNIT UN PARFAIT COMPROMIS AUX UTILISATEURS PARTICULIERS ET PROFESSIONNELS
-  DIE EINRICHTUNG, DIE EINEN PERFEKTEN KOMPROMISS VON DEM BASTLER BIS DEN PROFI BIETET
-  LA MAQUINA QUE DA UN PERFECTO RENDIMIENTO TANTO AL AMANTE DE LA HOBISTICA COMO AL PROFESIONAL
-  TÖKÉLETES VÁLASZTÁSEGYÉNI ÉSPROFESSZIONÁLIS FELHASZNÁLÓKNAK



Modello Model	A	D	E	F	G	Peso Weight Poids Gewicht Peso	 
SPIDER 150	820	3500	5200	-	-	200	310

Modello Model		Ø MAX		
SPIDER 150	cm 150	cm 3	kg 600	HP 25/40 cm 120



Frontoni Maurizio s.n.c. di Frontoni Maurizio & C.
Via Besenzone, 1/F - 29016 Cortemaggiore (PC) Italy
Tel. +39 (0) 523 839959 - Fax +39 (0) 523 839512

frontoni@frontoni.net

www.frontoni.net

